



# HAM HUM

Published by  
AK-SAR-BEN RADIO CLUB, INC. - Omaha, Nebr. 68101  
Post Office Box 291 - Downtown Station



Vol. XXV  
No. 11

November 1975

## NEXT MEETING

WHEN: FRIDAY, NOVEMBER 14, 1975

TIME: 7:30 P.M.

WHERE: NATIONAL GUARD ARMORY  
6929 Mercy Road, Omaha

PROGRAM: COVENANTS, LEGAL AND ZONING PROBLEMS IN  
REGARD TO ANTENNA STRUCTURES by Leo F.  
Connolly, KØJIU and James E. McShane, WAØLHC

REFRESHMENTS—EYEBALL QSOs—VISITORS WELCOME

\*\*\*\*\*

**HAM HUM** is the official organ of the Ak-Sar-Ben Radio Club, Inc., of Omaha, Nebraska, mailed monthly to all members and to others upon request.



Next copy deadline: November 21st

**Annual Dues:**

Regular member .....\$7.50  
 Regular member and XYL ..... 9.00  
 Student member ..... 3.50  
 (due and payable each Jan. 1)

Published by

AK-SAR-BEN RADIO CLUB, INC.  
 Post Office Box 291  
 Omaha, Nebraska 68101

Editor: Dick Eilers, WØYZV

Phone HOME: 397-3999  
 BUSINESS: 342-1402 - EX. 2

Associate Editor: John Snyder, WØWRT

Phone HOME: 556-1538  
 BUSINESS: 397-3000 - I.X. 3761

Associate Editor: Ervan Heinz, WAØEEM

Phone HOME: 553-2033  
 BUSINESS: 554-2656

New member initiation fee .....\$1.00  
**Quarterly for balance of year:**  
 Regular member .....\$2.00  
 Regular member and XYL ..... 2.45  
 Student member ..... 1.00

**ANNOUNCING 1976 CODE AND THEORY CLASSES**

Volunteer members of the Ak-Sar-Ben Radio Club, Inc. will again conduct code and theory classes in 1976.

The place: CREIGHTON PREP, 7400 Western Avenue, Omaha (use west parking lot).

Code and theory classes will be held **TWO NIGHTS A WEEK** and will be conducted concurrently — one for those preparing for novice privilege and the other for those preparing for general and above. The AMECO Amateur Radio Theory Course textbook will again be used.

Classes will convene the first week in January 1976 and will continue for approximately fifteen weeks. Exact dates and class schedules will appear in the December issue of **HAM HUM**.

\*\*\*\*\*

**ADVERTISING RATE SCHEDULE FOR HAM HUM**

	<u>Per Issue</u>
Full page .....	\$15.00
One-half page .....	8.00
One-fourth page .....	4.50
One-eighth page .....	2.50
One-twelfth page .....	2.00

Specials

Front (three-fourths page) ....	20.00
Inside front cover .....	18.00
Inside back cover .....	17.00
Center spread .....	32.00

Above prices are for camera ready copy.

Ham ads free, subject to space limitation. Name, call, address and telephone number must be furnished.

\*\*\*\*\*

## ADDITIONS TO ROSTER

Lyman B. Longstreth, WØAUH  
6127 Pinkney Street  
Omaha, Nebraska 68104  
Phone: 553-6810

William E. McConnell, WA6WFI  
7608 Teal Street  
LaVista, Nebraska 68128  
Phone: 339-3467

John Charles Ragan, WNØQAD  
1255 Fairview Drive  
Blair, Nebraska 68008  
Phone: (402) 426-4740

Bernard K. (Bernie) Skoch, WA5VPE  
2711 Vandenberg/Capehart  
Omaha, Nebraska 68123  
Phone: 291-7639

Donald F. Taute, WBØPGS  
2314 South 40th Street  
Omaha, Nebraska 68105  
Phone: 556-6695

\*\*\*\*\*

## MEMBER NEWS

James R. Peterson recently received his technician class license and his call is WBØQGV.

LeRoy Hilt recently received his advanced class license. His new call is WBØMSN.

A card from Joe McCool informs us that his new call is WBØNFF.

Also just received information to the effect John Gebuhr, WBØCMC, passed his advanced; Rick Stansbury, WAØROP, passed his general; and Gary Maples, WØOXT, received his general license and recently passed his advanced in Lincoln.

Congratulations to you all!

\*\*\*\*\*

November 1975

## OCTOBER MEETING

By—Bill Leatherwood, WAØZUR

The regular meeting was held at the National Guard Armory on 10 October 1975.

A Resolution of Appreciation was authorized for presentation to the Lincoln Amateur Radio Club, Inc. for their assistance after the May 6 tornado. This Resolution was to be presented during the ARRL Midwest Convention in Lincoln.

Members who passed the Advanced test in Omaha are: Frank, WBØJAX; Mel, WA7VIL; and Chet, KØPTG. We understand that John, WBØCMC, went from Tech to Advanced in Lincoln. If we missed anyone, please let us know. Congrats to those who were successful, and condolences to the others.

Marty, WAØGEH, won the door prize.

Messrs Arnold Johnson and George Killebrew presented a most interesting program on Radio Astronomy. Mr. Johnson has pictures of antennas located throughout the world. Of special interest to hams is the frequency range at which these astral radiations are received. The receivers used, and the extremely low power of the incoming signals made quite an impression as well. It's another facet of radio which might prove interesting for amateurs.

We thank the gentlemen, and congratulate Ed again on his fine selection of programs.

\*\*\*\*\*

There are two kinds of men that never amount to much—those who cannot do what they are told and those who can do nothing else.

Karem Karavan

\*\*\*\*\*

HAM HUM

Page 3

# 1975 MULTIPLE SCLEROSIS BIKE-A-THON

By—Bob Lockwood, WAØDHU

At 9:00 A.M. on Sunday, September 28th, 99 bike riders headed from Boys Town to Linoma Beach and back in the 1975 fifty mile Bike-A-Thon for Multiple Sclerosis. The Ak-Sar-Ben Radio Club AREC again supplied communications for this event.

We expanded our exercise this year by placing portable units at Douglas and Sarpy Sheriffs' headquarters and the Highway Patrol. This action linked these three agencies together for more effective coverage of the route.

Portable units were also set up at WOW, KOIL and KLNG radio stations to supply information to the media on the progress of the Bike-A-Thon.

Following is a list of those participating in this exercise and the position each manned: NCS at Boys Town (Check points 1 & 7)—Lynn, WAØODH and Jack, KØUDK; Check points 2 & 6—Chet, KØPTG and Earl, WAØTMG; Check points 3 & 5—Lloyd, KØDKM; Check point 4—Butch, WBØNGD and Don, WBØPGS; Douglas County Sheriff Hq.—Bill, WBØNPS; Sarpy County Sheriff Hq.—Ed, WBØBCB; Highway Patrol—John, WBØCMC; KOIL Radio

Station—Chuck, WBØNVL; WOW Radio Station—LeRoy, WBØMSN; KLNG Radio Station—Bob, WAØDHU; Bike repair truck—Jo, WBØMNK; Van between check points 1 & 3—Mike, WBØBMV; Truck between check points 2 & 4—Marty, WAØGEH; Mobile between check points 1 & 2—Bill, WBØIKL; Mobile between check points 2 & 3—Larry, WØKCK; Mobile between check points 3 & 4—John, WBØPEX; Press car—Jim, WBØQGV; Chuck Wagon—Cecil, WØRMB; KLNG in the afternoon—John, WBØOSZ and after 2 P.M.—Don, WBØPGS from check point 4; Bill, WBØIKL followed the last bike rider; Jim, WBØQGV at the lead or where large pledge bikes were located; WAØGEH directed initial traffic at 144th and Pacific; and WBØBMV directed initial traffic at Pacific and Highway 6.

The Net Control Station did an outstanding job directing the net activities and those assigned handled their jobs like professional communicators. An outstanding net operation was the result. Our thanks goes to all these amateurs for a job well done.

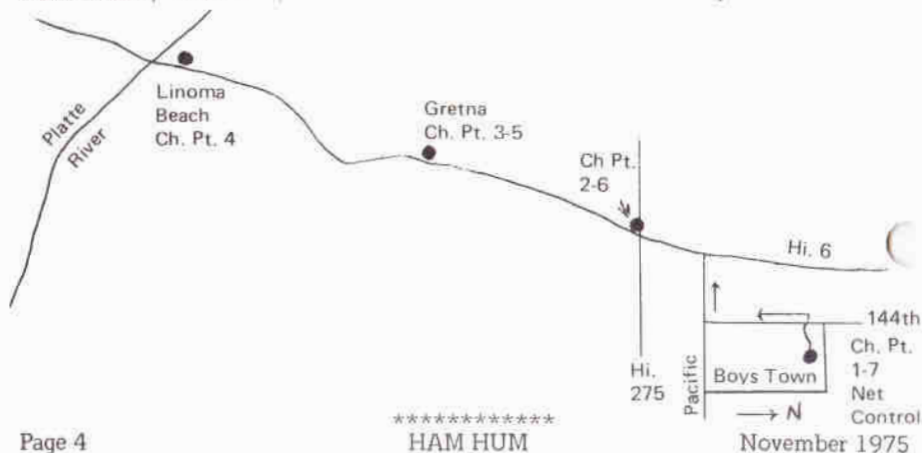

## MAYOR'S TORNADO STUDY COMMITTEE

On October 15, 1975, Gary Maples, WØOXT, and John Gebuhr, VBØCMC, accompanied by Dick Eilers, WØYZV, presented the story of our activities for the record of the Tornado Study Committee. In addition to making the report and commenting on our abilities to provide emergency communications, a very brief on-the-air demonstration was held wherein several stations did check in, including the Lincoln Emergency Coordinator.

Many thanks to those who checked in. Whereas the test was brief, it was effective.

\*\*\*\*\*

CONTRARY TO POPULAR BELIEF AND PRACTICE, when signing clear of a QSO you are required to give the call sign of the station (or one of the calls of a group of stations) you were in contact with followed by your own station call. Signing W9XXX clear just won't do it.

THE FCC HAS BACKED OFF on its requirement that control codes be listed with the district engineer. They also don't want your telemetry codes - yet. Repeater Trustees wait until they make up their minds on just what they want. (IRC Newsletter, 12-74).

RENEWING YOUR REPEATER LICENSE? If the system is still as your original application says it was, you need only file the form 610, with no additional information. However, you must file renewal of *all* your licenses, primary, control, repeater, link, etc. at one time and in one package! (IRC Newsletter, 12-74)

November 1975

## RECENT CONTRIBUTORS

### Repeater Fund

Steven M. Bailey, WAØGQG  
James R. Peterson, WBØQGV  
Mike Wilczynski, WBØBMV

### Repeater and Autopatch Fund

Jon K. Taute, WBØMNK

### Ham Hum Postage

Donald J. Launer, KØRJE

Sincere thanks to all!

And a special thanks to LeRoy Hilt, WBØMSN, for his generosity in donating a Power Supply to the Club.

\*\*\*\*\*

WHO CAN OPERATE YOUR STATION? According to the new FCC regulations, it is alright for anyone to operate your station, on any band which is legal for you, as long as you are somewhere nearby and "in control." The only restriction to this is another licensed amateur with a lower class of license than yours - they are restricted to the bands and modes of their license. (The Radiops Log, 12-74)

CLEGG FM-27B PRODUCTION SOON TO STOP. With a new, fully synthesized FM rig in the making, the FM-27B will be discontinued in the near future. It is rumored the new "clickety-click" (not tunable, thank heavens) will provide 5KHz switching, may reach into the MARS and CAP region, **have** repeater split offsets and still **have a price** in the range of the 28B!! (The Radiops Log, 12-74)

de N.E. Indiana UHF Associates

HAM HUM

Page 5

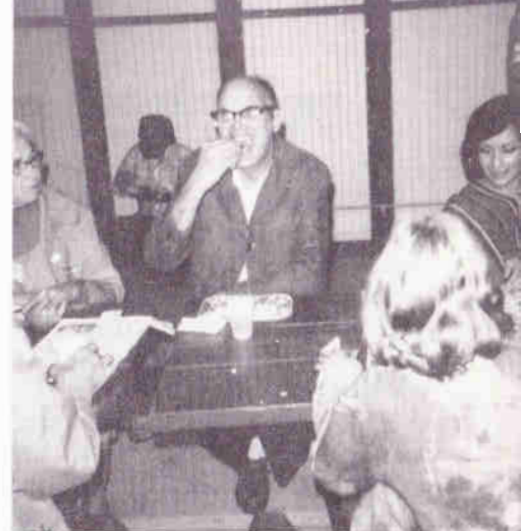
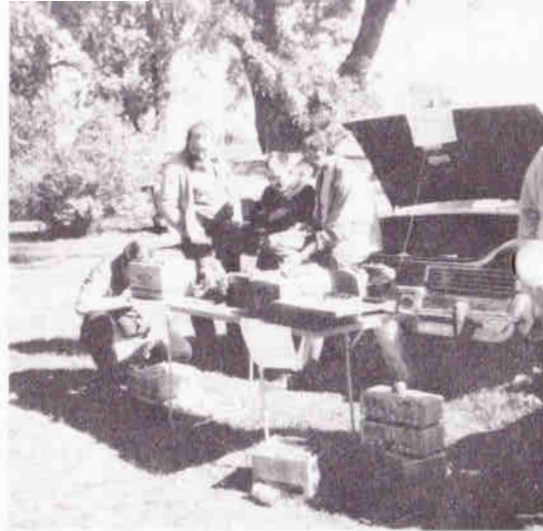
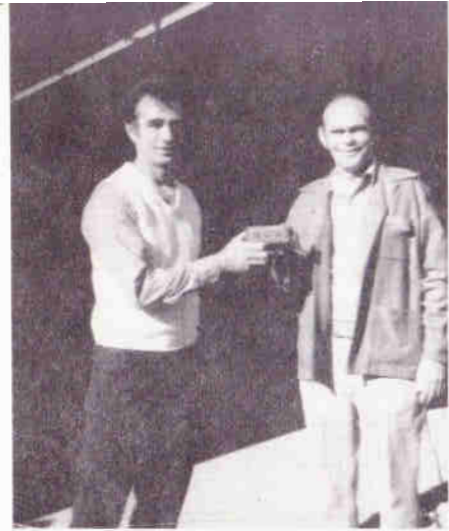

Photos of Family Picnic and Back End Flea Market held at Missouri Valley City Park, Missouri Valley, Iowa, on September 21st.

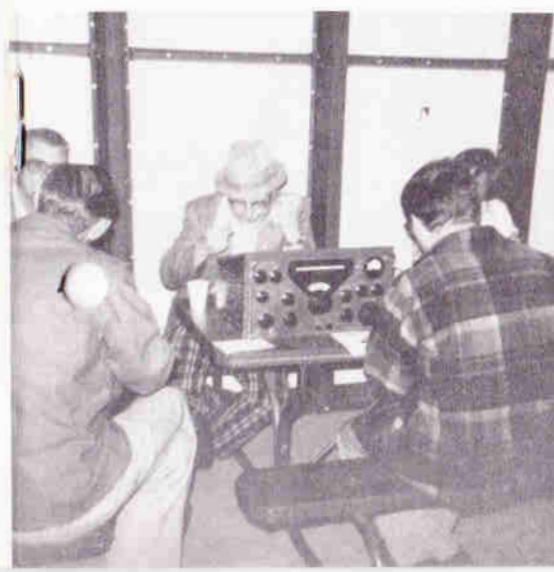
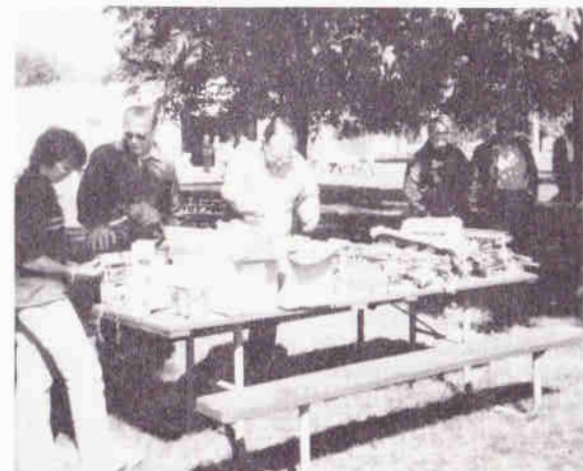

## THE OYSTER AND THE EAGLE

"When God made the oyster, He guaranteed him absolute economic and social security. He built the oyster a house, a shell to protect him from other animals and other oysters. When hungry, the oyster opens up his shell and food rushes in.

"But when God made the eagle, what did He do? He said, 'the blue sky is the limit. Get out and build your own house.' The eagle builds his house on the highest mountain crag where danger and disaster threaten him every day. For food he flies through a thousand miles of rain and snow and wind and mountain.

"The eagle and not the oyster is the emblem of America."

*Christian Leadership Manual*  
Author Unknown

Let us not be like the oyster, but  
like the eagle!

\*\*\*\*\*

### NEWS NOTE

It may be of interest that the first examination for a novice grade amateur license, recently introduced in Australia, was held on 24 June. Briefly, the conditions are: Morse Code 5 wpm; low level theory; full regulations; cw & phone; 10 watts; Bands 3.525 - 3.575 MHz, 21.125 - 21.200 MHz, 26.96 - 27.23 MHz; crystal controlled.

VK2APQ via WØFQB

\*\*\*\*\*

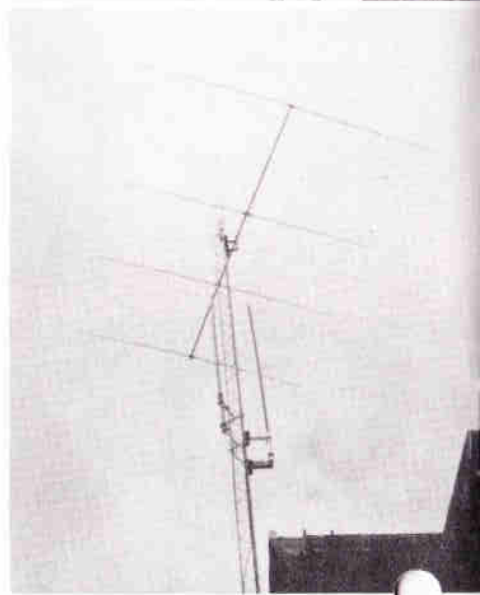

Antenna Raising Party at  
Red Cross Chapter House

Photos submitted by  
Charles Michel, KØQVL  
November 1975

## ANOTHER LIGHTNING HAZARD—THE ROTOR CABLE

From S.P.A.R.C.-G.A.P.

K4NE

So you feel safe after you have disconnected or grounded the antenna feed line? Not necessarily! If you have a rotatable beam or quad, there is usually an 8 or 4 wire cable connecting the rotor mechanism with the rotor control box. This cable leads down the mast or tower into the control or operating room. Unless there is some form of disconnect between this cable and the rotor control box, part (usually too much) of the lightning surge at the antenna or tower will find its way into this cable. Very often this cable runs parallel with the coax used as an antenna feed or transmission line. This enhances the chance of capacitive pickup from the braid of the coax, since the rotor cable is usually unshielded.

In one case, nature added to a July 4th local fireworks display by lightning which struck the upper tip of a fiberglass quad spreader holding the 20 meter fed element of a quad at K4NE. The last six inches of the spreader disappeared, leaving a "puffball" of fiberglass resembling a feather duster or cotton ice cream cone such as one finds at carnivals. The eyebolt holding the antenna wire was unharmed but dropped down since its support was lost. There was no damage to the antenna or coax transmission line.

All the antenna feeds were disconnected and grounded outside the shack. Yet the lightning surge entered the house thru the rotor cable,

burned out the CDR control box, entered the strip-line 120 volt a.c. connection strip thru the control box a.c. cord, passed into the receiver and exciter which had their a.c. cords plugged into the stripline, and caused considerable damage to the receiver and exciter. Some of this could have been avoided had the a.c. cords been disconnected. But the best preventative measure would have been to disconnect the rotor cable.

There is an eight-pin Jones plug disconnect in the rotor cable outside the shack now which can be connected to a ground plug, all eight connections strapped together and wired to a ground rod. Truly a few ounces of prevention are worth a few pounds of replacement parts!

Via FLORIDA SKIP

\*\*\*\*\*

## REI

Radio Engineering Amateur Radio Club will be sponsoring a fund raising show in the near future. Specific dates and times will be announced on AREC nets and in next month's Ham Hum.

KØEXK

\*\*\*\*\*

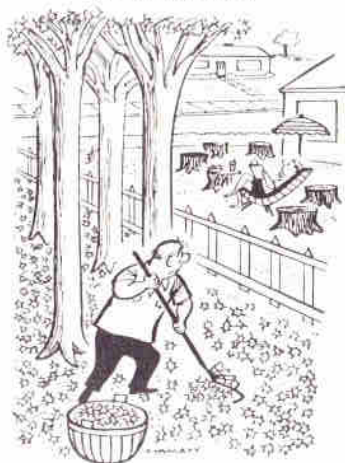



# 100 KHz BUREAU OF STANDARDS OSCILLATOR

By Joe Rice, W4RHZ

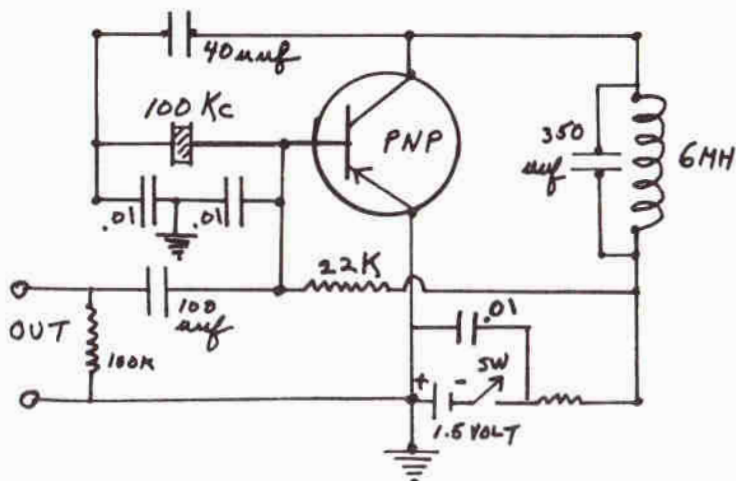

Back in 1968 I ran onto an excellent circuit for a stable 100 KHz oscillator. It is a simple circuit and portable. In actual use it can be coupled directly to the antenna circuit of your receiver or coupled to a flip-flop circuit used for a divide-by-ten to obtain 10 KHz calibration points. According to measurements carried on at the Bureau of Standards in Washington, the frequency is constant to approximately 1 part in 100 million per degree centigrade. A variation of 0.1 volt in the supply potential causes a frequency shift of only 1 part in 100 million.

As is evident in the circuit, the oscillatory voltage in this common-emitter configuration is developed across the 6 MH coil and 350 mmfd. cap. The .01 capacitors connected to

common ground from each side of the crystal assist in maintaining the phase-shift in the crystal feedback circuit constant. The resistor in series with the tank circuit and battery (100 ohms) is inserted for safety purposes; without it the DC resistance in series with the oscillator would be virtually zero and the current would rise to damaging figures. Thus, the 100 ohms resistor serves to limit the DC flowing through the collector circuit at all times. DC bias is applied to this electrode through the 22K resistor and oscillatory output is taken from the base via the 100 mmfd., capacitor while the 100K output resistor serves as a constant load on the circuit.

Reprinted from MIKE & KEY  
Via W6SD Carrier

\*\*\*\*\*

# HAM HUM SWAP

**WANTED:** I plan to operate on Grand Cayman Island next March. Need to rent compact SSB Xcvr with built-in AC supply, such as Cygnet, FT-101, etc. Willing to pay a reasonable fee for loan of rig. Call will be ZF1DB.

Dave Benton, KØVVO, 3616 South 101st St.,  
Omaha, NE 68114; phone 422-3373 or 391-8975.

**FOR SALE:** Sylvania VTVM Type 134—\$20.00; Heath VTVM Model V-4A—\$15.00; Calrad Microphone Mixer—\$3.00; Challenger P.A. System with 2 speakers—\$35.00; Hallicrafters SX-96—\$115.00; Johnson Valiant and Frequency Calibrator—\$125.00; Johnson Viking Ranger—\$80.00; Trapped vertical 40 Meters—\$25.00. Will consider any fair price.

Call 731-0161, Mrs. Jerry Novotny,  
5450 So. 50th Ave., Omaha, NE 68117

**WANTED:** Used Ham Tower 25 foot, around 50 dollar range; also used TR-44 Rotor, around 45 dollar range.

Call 734-3672, David L. Daniel, WAØSVO,  
6728 South 52nd Street, Omaha, NE 68117

**FOR SALE:** Newtronics Hustler 2M; Colinear Antenna Model CGT-144; 5.2 DB gain Mobile antenna. \$30.00.

Kent Sinram, WØBOR; phone 571-7423  
9705 Hartman Ave., Omaha, NE 68134

**FOR SALE:** Heathkit QRpp Xcvr HW-7; MFJ Regulated Power Supply 12V; Hammarlund HQ129X General Coverage Rcvr; Vibroplex Bug.

Joe Nanos, KØKES; phone 339-7865 evenings.

**FOR SALE:** A large accumulation of ham gear and parts. For further information, please contact me at my home or call 455-7143. Everything in good working order.

Lou Cutler, WØVLI  
6227 Florence Blvd., Omaha, NE 68110

\*\*\*\*\*

Have you heard about the short-tempered telegraph operator who was so quick at he quit a job in the middle of an "E"?

The rig here is so old we insured it against theft, fire and Indian raids.

On pennies, we are told, the "In God We Trust" was put there for the benefit of those radio amateurs who use them for fuses.

Reprinted from MIKE & KEY Via W6SD Carrier

\*\*\*\*\*



**Hobby  
Industry**

**WE HAVE  
MOVED TO  
1601 AVE "D"**



73 *al*  
wφJJK

**"D"**



THREE PRE-CHRISTMAS BARGAINS BELOW  
GOOD NOVEMBER 75, NO-TRADE DEALS.

J8-24 CLOCK (Reg. \$18.95) WITH 8" FACE, SWEEP SECOND HAND, 24 HOUR DIAL. ALONE.....\$ 16.00 .  
\$12.00 WITH A \$200.00 ORDER

REGULAR \$32.95  
NOV. \$27.95  
TAKE IT AT \$25  
WITH \$100 ORDER.



SOUND-OFF with the Shure 444 mike, the best dynamic available for the amateur. Tailored for 5SB with 300/3000 cycles, and high impedance for all popular - new and older gear. Really terrific response and output (-53DB at 100K Ohm). PTT & VOX circuitry, adjustable height, 3LB.

MIDLAND 13-500 2M/FM TRANSCEIVER, REG \$259.00  
BONUS SPECIAL! 10 CRYSTALS



34/94/94/16/76  
& YOUR CHOICE  
OF 5 OTHER ST  
FREQ. CRYSTALS  
ALL FOR \$219 !

STORE HOURS ARE: TUES. - WED. - FRI. . . . . NOON TO 5 PM.  
THURS. . . . . NOON TO 8 PM & SAT. . . . . 9 AM TO 5 PM.