



HAM HUM

Published by

AK-SAR-BEN RADIO CLUB, INC. - Omaha, Nebr. 68101
Post Office Box 291 - Downtown Station



Vol. XXII
No. 1

January 1972

NEXT MEETING OF AK-SAR-BEN RADIO CLUB, INC.
WILL BE HELD AT RED CROSS CHAPTER HOUSE, 432
SOUTH 39TH STREET, OMAHA, AT 8:00 P.M. ON
FRIDAY, JANUARY 14, 1972.

DO IT YOURSELF NIGHT - AN ADULT, BUT
AMATEUR, SHOW AND TELL.

FOR FURTHER DETAILS SEE PROGRAM NOTES ON
PAGE 8.

HAM HUM is the official organ of the Ak-Sar-Ben Radio Club, Inc., of Omaha, Nebraska, mailed monthly to all members and to others upon request.



Next copy deadline: January 21st

Published by
AK-SAR-BEN RADIO CLUB, INC.
 Post Office Box 291
 Omaha, Nebraska 68101
 Editor: Dick Eilers, WØYZV
 Phone HOME: 391-2255
 BUSINESS: 342-1402 - EX. 35
 Associate Editor: John Snyder, WØWRT
 Phone HOME: 556-1538
 BUSINESS: 536-4460
 Associate Editor: Ervan Heinz, WAØEEM
 Phone HOME: 553-2033
 BUSINESS: 553-4700 - EX. 331

1972 COMMITTEE CHAIRMEN

Repeater Committee
 Civil Defense Committee
 Community Relations Committee
 Public Relations Committee
 Inter-Government Relations Comm.
 Mobile Committee
 Publications Committee

Technical Committee

Membership Committee
 Program Committee

Activities Committee (Field Day)

Refreshment Committee

James C. Droege, WØYCP
 Dick L. Eilers, WØYZV
 Dick L. Eilers, WØYZV
 Hugh L. Tinley, KØGHK
 Leo F. Connolly, KØJIU
 Raymond F. Kydney, WAØWOT
 Dick L. Eilers, WØYZV
 John D. Snyder, WØWRT
 Ervan D. Heinz, WAØEEM
 Leo F. Connolly, KØJIU
 Dr. Edward A. Holyoke, WAØVSR
 Alvin (Al) Comisar, WAØSTK
 Robert D. Andrus, KØLUG
 Bryan R. Zdan, WBØAJI
 Marion (Mike) Wilczynski, WAØBMV
 Raymond F. Kydney, WAØWOT
 Jon Russell Minks, WAØVEE

12/14/71

Greetings to all:

Since moving to Missouri we have had occasion to be in the Omaha area a number of times, both in the auto and the Cessna Skyhawk. In the plane in your area, once we get up a thousand feet or so, the PT-300 will pull up two or three different repeaters.

In all our travels throughout the upper midwest, the only problem we

encounter on 2 meters is the act of breaking a QSO. The participants of an existing QSO work very close push to talk, thereby making it hard to break. This seems to be the only real shortcoming to VHF radio operation.

We enjoy very much the 2-meter operation and hope you continue your fine facility.

73,
 Bill Hendrix, WØFCE

1972 BOARD OF TRUSTEES

President	Edward F. Askew, WAØRDZ	(1972-73)
Vice President	Robert D. Andrus, KØLUG	(1972)
Past President	James C. Droege, WØYCP	(1972)
Executive Council	Alvin (Al) Comisar, WAØSTK	(1972-73)
	Leo F. Connolly, KØJIU	(1972)
	Dr. Edward A. Holyoke, WAØVSR	(1972-73)
Treasurer	Charles F. Kelly, WAØUZX	(1972-73)
	Raymond F. Kydney, WAØWOT	(1972)
Secretary	Russell A. Minks, WAØVEE	(1972)
	Marion (Mike) Wilczynski, WAØBMV	(1972)
	Bryan R. Zdan, WBØAJI	(1972-73)

PAST PRESIDENTS OF THE CLUB

1945	Nels Peter Nelson, W7RCF (Ex-WØYDC)
1946	John F. Leeder, WØUFD
1947	Arthur R. Gaeth, WØFQB
1948	Herbert D. Curry, WØQXR
1949	Elmer N. Stein, Ex-WØAVM
1950	Dr. Leon Becker, W6AID (Ex-WØBBX)
1951	Earle E. Olson, WØJKE
1952	John W. Orr, WØPHW
1953	Rev. R. J. Strange, WØQHG
1954	Frank W. Cooper, W3NV (Ex-WØIOS)
1955	Arthur E. Stadler, W9KHD (Ex-WØQMD)
1956	Dick L. Eilers, WØYZV
1957	Curtis D. Hicks, KØAMM
*1958	Edward Gutmann, WØCQX
1959	David A. Hollander, W6COJ (Ex-WØCJW)
1960	Max N. McKinney, WØYVV
1961	John A. Droescher, KØKWB
1962	Royal M. Enders, KØLYO
1963	Joseph F. Berounsky, KØQDB
1964	Louis A. Cutler, WØVLI
*1965	Edmond E. Donze, WØYEV
1966	Byron J. Smith, Sr., WAØICK
1967	Ervan D. Heinz, WAØEEM
1968	Robert C. Lockwood, WAØDHU
1969	Royce E. Johnson, WAØKIL
1970	Harold E. McClenahan, Jr., WAØDGA
1971	James C. Droege, WØYCP

*Deceased

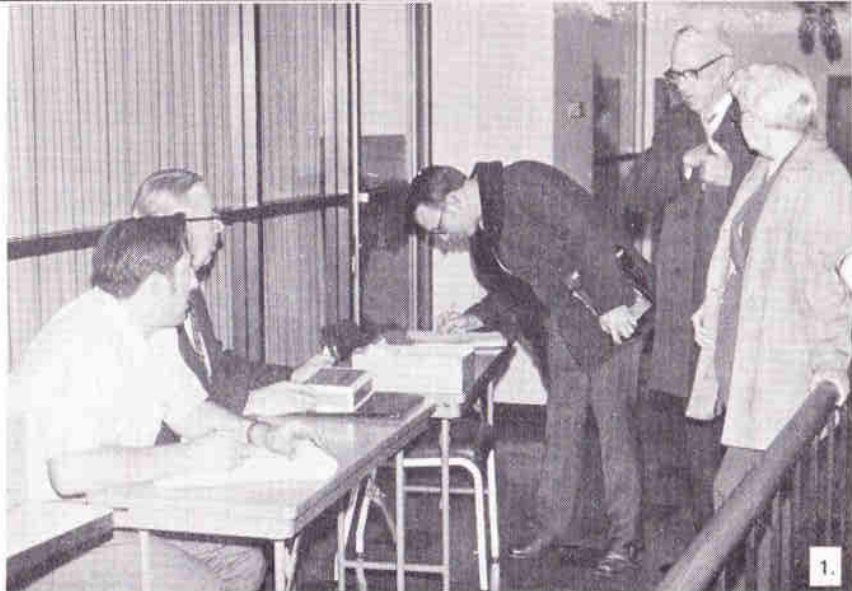

ANNUAL MEETING AND CHRISTMAS PARTY

By—Ervan D. Heinz, WAØEEM

The 1971 annual meeting and Christmas party of the Ak-Sar-Ben Radio Club, Inc. was held on December 10th at the cafeteria of the World Insurance Company. Members logged in with "Happy Hank" Dworak, WAØQLE; Harold McClenahan, WAØDGA, was the official greeter (picture 1).

A welcome and greeting was given by President Jim Droege, WØYCP. Dick Eilers, WØYZV, Chairman of the

Nominating Committee, then presented the slate of officers for 1972 with President Droege, WØYCP, and Secretary Snyder, WØWRT, looking on (picture 2). Following this a nomination was made from the floor for Randy Curtis, WNØDDZ, as a member of the Executive Committee. Balloting took place for election of officers with those selected by the Nominating Committee having the majority of votes.





Our top-notch Secretary, John D. Snyder, WØWRT, recognized President Jim Droege with a plaque for his outstanding service to our Club during the past year (picture 3). Among his accomplishments was a considerable growth in membership in the Club. Pictures 4, 5, and 6 show our energetic President awarding Membership Certificates to new members.





Welcome aboard! Picture 7 shows the enthusiasm of Club members in having the Snyders from Fremont, (Harry, WØNVE, and Pat, WAØTTW) join our Club.

Reigning President Jim Droege, WØYCP, then turned the gavel over to President-Elect Edward F. Askew, WAØRDZ (picture 8).

Jr. Op Bill Snyder (picture 9) kicked off the gift exchange with a drawing for the ladies' door prize. Picture 10 reveals a few of the XYLs; also Bob Lockwood, WAØDHU, who reminded the members of the upcoming free Code and Theory classes scheduled to begin on January 3, 1972. Fifteen weeks of professional growth!



We enjoyed special entertainment by accordionists Chris Bojanski and Susie Sander who provided Christmas music, and "Singing Bob," WAØDHU, (pictures 11 and 12) belting out the

cs, moved the hams into caroling. The working XYLs are to be commended for their baking (picture 13). The cake, cookies, ice cream, pop, and coffee were enjoyed by everyone. Picture 14 shows some of the children enjoying their crackerjacks.

On behalf of the Club, we sincerely thank the World Insurance Company for their hospitality, facilities, and Season's Cheer.



PROGRAM NOTES

With the Christmas party behind us now, new officers have been assigned their new jobs. Guess who the program chairman is? No one could be more surprised than yours truly to be railroaded into this position.

Anyway, this is the way we have in bringing the program for the January meeting. For those hams who still take the time to sweat over designs, make up bread-board ideas, and then finally get their pet project to give out with its first bit of noise, this program is for them. You might call the program "Do It Yourself Night" or for those not so inclined, "Show and Tell." Whatever you want to call it, please come to the Red Cross Chapter House for a good program.

For those who do build their own equipment, please bring something to talk about, even if it has been built for some time. We want not only items of interest, but also ideas that might be on your drawing boards.

For the real builder and modifier of ham gear, we have a treat. WAØEMU, Neal Johnson will have on display a Fax Machine with some description and a talk on how to put these units into good use on the ham frequencies. The nice part about this last item is that a few will be given away to the hams who will put them on the air. If you don't come to the January meeting, you will be missing a good night.

Bob, KØLUG

The best way to save face is to keep the lower part of it closed.

FOR SALE

Ham Rotor
Converted Prop Pitch Motor

Lou Olsen, WNØFFA
6306 N. 32nd Street
Omaha, Nebraska 68111
Phone: 451-0557

Dec. 17, '71

Ham Hum
Ak-Sar-Ben Radio Club
Box 291 - Downtown Station
Omaha, Nebraska 68101

Hi,

Recently the Fremont FM'rs were presented an opportunity by ØYCP to further participate in the repeater project.

Jim needed a "black box" to switch tape recorders when the first one ran out of tape. This was designed by ØYCP - ØNVE, beautifully constructed by ØKQE and installed by ØAW, ØKQE and ØNVE. The parts cost was shared by ØAW, ØKQE, ØUVU, WAØHBS, ØQOU, ØWR, WAØWFR and WAØUGD.

The repeater is great and we're looking forward to the next project - Oh yes, WAØTTW had his nose in too. Vy 73,
WØNVE
H. C. Snyder

(Ed. Note: Sounds terrific. Many thanks from the Club and repeater users. Ham Hum would like to know "How you do that?")

Since publishing the December 1971 issue, a letter was received from another former Past President of the Club. It is quoted here for your interest.

December 6, 1971

Mr. Dick L. Eilers, WØYZV
AK-SAR-BEN RADIO CLUB, INC.
Post Office Box 291
Omaha, Nebraska 68101

Dear Dick:

First of all, I want to apologize for not responding to your kind request of October 21 to attend the Past Presidents' Night at the Ak-Sar-Ben Radio Club which was held November 12.

I had really planned to attend, but unfortunately, our plant in Pittsburgh went on strike and all of my plans had to be stopped. As this action came at the same time, I had not responded to your letter.

The strike is still on and I have been extremely busy attempting to satisfy our customers from our other two operations. During a lull this morning, I decided I should drop you a note and not only apologize, but pass on a little information which might be of interest to some of the Past Presidents and old members who might remember me.

Basically, Dick, my activities in ham radio have been limited as a result of my new love for flying. I do listen occasionally when I have knowledge of any new country or DX-Pedition. My country worked total as of this date is 303 with confirmations for 296. My operating time is limited to, perhaps, one or two hours per month, so the count has not changed very much over the past 12 months.

I still enjoy reading the club paper and am enclosing herewith \$10.00 to

help your postage bill for 1972.

I still occasionally at 1800 on Sunday talk with Ferris Kramer, WØYZK and others.

The greatest portion of my free time is spent flying my new CHEROKEE ARROW. Between this activity and running my plants, I keep pretty busy.

Again, Dick, please excuse this long delay in response to your kind letter, and perhaps next year, I might be able to attend.

Best regards to all.

Sincerely,

Frank

F. W. Cooper, W3NV

(Ed. Note: Many thanks, Frank, for your letter and contribution to the Ham Hum postage fund.)

WANTED TO BUY

6 meter transceiver, good condition and reasonably priced.

Kevin J. Clatanoff, WAØYCC

1302 Englewood Drive

Bellevue, Nebraska 68005

Phone: 292-0121

FOR SALE

Hammarlund HQ 110 Receiver \$40.00

Knight T-60 Transmitter and

TR Switch \$15.00

Heathkit Q Multiplier \$5.00

Cambridge 2 meter Transceiver,

Model 7010-UPM-20 watt-

commercial outfit-can be

converted \$130.00

or make offers.

Roger Langpaul

Phone: 345-7917

2618 South 35th

NOTES FROM WØWRT

Gentlemen:

It has been my pleasure to serve the Club as Secretary during this past year and I trust that your new Secretary, Russ Minks, WAØVEE, will get some enjoyment from this position too. I believe that the Board of Trustees has certainly covered a lot of ground this past year, considering the advances with the Club's radio repeater (new rec. sites).

In connection with the repeater, I think that one of the biggest challenges facing the new Board will be in the field of liaison and frequency coordination with other nearby clubs such as Lincoln, Des Moines etc. in order to alleviate the mutual interference problems which are apt to arise. As long as we as radio amateurs keep on communicating in a spirit of friendship, these problems surely will be solved.

I still don't think we are doing the job of selling ourselves as we could in the area of public service. I realize that one attempt we did make was rejected; however, this does not mean that we should stop trying.

We all should give serious consideration toward the use of other VHF frequencies for our FM activity, especially 50 mhz, 220 mhz, 440 mhz and even 29 mhz. Lots of equipment is currently available for 3 of these bands anyway. The 220 mhz band presents a particularly good challenge for the ham who still feels that there is a place for the man who likes to build his own equipment. Not an impossible task by any means. I feel that this is especially critical in view of the remarks made by Mr. John Huntoon,
10

W1RW of ARRL recently before the Pueblo, Colo. club in which he said that there is probably a 50-50 chance that we could lose all or maybe part of the 220 mhz amateur band to other services. Can we afford to let that happen?

John D. Snyder, WØWRT
Associate Editor

Centuries ago salt was a luxury for which adventurers risked their lives and kings sold their jewels. Today in America more salt is sprinkled on slippery highways than on food.

— Service

CALLBOOK CHANGES POLICY

As a result of a nationwide survey, the Callbook is changing to one major edition per year, with no change in price. Publication date is December 1st, beginning with the Winter 1971-72 issue.

However, a "new information service" in Callbook form, consisting of new licenses, silent keys, call letter and address changes for the preceeding three months, will be initiated on a quarterly basis — every March 1, June 1, and September 1 — to those who have purchased the previous December issue. This information service will be available by subscription only, through the order form printed in the December edition. The price for this service will be \$6 per year for the United States series, and \$4.50 per year for the Foreign series. The subscription is on a consecutive, annual basis only.

de The RaRa Rag

UNTIL DEATH DO WE PART

To a lot of women, "ham" is something that you have on Christmas, Easter, or some special day of the year. To me, "Ham" is the word used most often to describe the man with whom I agreed to spend the rest of my life! At first it wasn't bad. The "equipment" in our home was only a small, fairly quiet two-way radio. On it, we listened to some men talk in a sort of funny language to each other. If I sat and really paid attention, I could manage to understand MOST of what was said...but, there was always some smarty who threw in a phrase like "balanced modulator, phase shift or crystal filters."

It got worse, fairly quick. For what seemed like an awfully long time, I heard all sorts of "tapping" noises coming from the shack. My love was going to get a license of some sort I was told! Well, after forty forevers, he finally did get a license. But, it was just a "little" one...all he could do was "tap" on a key. Then, after a little while, he began really studying and got a "big" license! He could actually get on that little black box with all the knobs and open his mouth and let words come out. I was thrilled to death!! MY HAM was going to really get on the air...little did I know that was just the beginning of many late suppers, late appointments, and undone odd jobs around the house!

Being a fairly orderly-type housekeeper, I was appalled to find little stemers cluttering up my dining room table when I had prepared a very nice meal and planned to set an equally nice table! Let me tell you, a platter of fried chicken just loses some of its glory sitting next to a half-built

transmitter!! But, I kept telling myself, "soon as he gets this built, he'll be through." It's really funny how wrong one can be!!!!

Then came my first encounter with a Ham-Fest. I was told it would be gobs of fun, laughter and frolic. So, with kids in tow, we set out on our first! I was all prepared for a lovely picnic with MY husband proudly showing off his "XYL" (by then I was almost an expert on those sort of terms) and "Jr. Op's." Bless my soul, I almost had to put him on a leash to keep from losing him to the "Swap Table"! But, we had fun. We met lots of other Ham families and I got to see that there really were other wives who shared my "burden"!

Yes, to me "Ham" is the word used most often to describe the man with whom I agreed to spend my life...even though I secretly wonder if I'm not really second in line to the latest model Transceiver, I feel lucky! After all, when you tell others that your husband is a HAM, you sure do get some odd comments...some full of sympathy, some full of comedy, and a lot that are full of admiration. For those comments that are full of sympathy, you immediately spring to the defense of Ham radio; for those full of comedy, you manage to make it clear that Ham radio is a serious business; and for those full of admiration, you remind yourself that this is the way you SHOULD feel all the time. After all, how many women are lucky enough to have HAM every day of the year?

Contributed by Bettie Sloat

XYL of K4VGN, Ft. Myers, Fla.
de Florida Skip

ADDITIONS TO ROSTER

Robert K. Hendricks, WNØEBA
2235 St. Marys Avenue—Apt. 521
Omaha, Nebraska 68108
Phone: 345-6743

Robert (Bob) L. Kelley
1102 Lincoln Street
Blair, Nebraska 68008
Phone: (402) 426-2779

F. L. (Lew) McAllister, WØZUI
8522 Meredith Avenue
Omaha, Nebraska 68134
Phone: 571-0219

Michael L. McAllister, WNØDXA
111 North 50th Street
Omaha, Nebraska 68132
Phone: 558-3349

Joseph H. Niemann, WBØFWB
4405 Morningside Drive
Omaha, Nebraska 68134
Phone: 571-3629

Francis M. Rahlfs
1064 Grant Street
Blair, Nebraska 68008
Phone: (402) 426-3239

Harry C. Snyder, WØNVE
Route 3
Fremont, Nebraska 68025
Phone: (402) 721-4457

Harry P. (Pat) Snyder, WAØTTW
Route 3
Fremont, Nebraska 68025
Phone: (402) 721-4457

Ned W. Valder, KØHRD/WBØFXK
Box 206
Missouri Valley, Iowa 51555
Phone: (712) 642-3659

A clock right in the center of a German heavy-industry town, Erlanger, tells the time on one face and voltages on another. When the volt-meter drops from the normal of 220V, the citizens help out the utility company by turning off electric appliances. —Service

MARS MEN

The name is the same as the planet but it has nothing to do with our space program. MARS stands for Military Affiliate Radio System and is composed of a world-wide network of amateur short-wave radio operators who provide a back-up system in case the nation's military communications system fails during an emergency.

These "hams" have also been providing a communications link between servicemen in Vietnam and their families in the United States. A serviceman in Vietnam can contact a MARS station in Southeast Asia and ask to place a call to the States. The station then tries to contact a MARS station in or near the U.S. city. The stateside MARS station, which is hooked into the telephone system, then calls the serviceman's family and links them up via telephone and radio. Members of MARS use their own equipment, donate their own time and do not charge for this service unless it involves a long-distance call within the United States. —Service

RECEIVER OFFSET TUNING

The circuit described below can be used in any transceiver to offset the receiver frequency from the transmitter frequency. The control for receiver frequency can be mounted on the front panel or external to the transceiver if resale value is of concern. With the values shown, the receiver frequency can be varied over a 5 kc. range without changing the transmitter frequency.

The coil of relay K1 is connected in parallel with the PTT relay and its contacts select either fixed or variable bias for diode D1. The bias voltage at the junction of R1 and R2 will be the same as the voltage at the center of the range of R5 allowing the receiver frequency to be varied above and below the transmitter frequency. Bias

voltage for the divider networks is taken from a low voltage source in the transceiver and regulated at 9 volts by diode D2. The capacitance of C1 and D2 in series is applied to the stator of the VFO tuning capacitor. Changing the bias on D1 changes its capacitance and, therefore, changes the amount of capacitance applied to the VFO. Capacitor C1 is an NPO ceramic, Zener diode D2 is a 9 volt unit with a 1 watt rating. Varactor diode D1 is Japanese made. Control R5 must have a linear taper.

With the extra capacitance applied, the VFO must be recalibrated. This involves only resetting of a trimmer capacitor on the VFO and will not affect the tracking. Bob - W4DZF

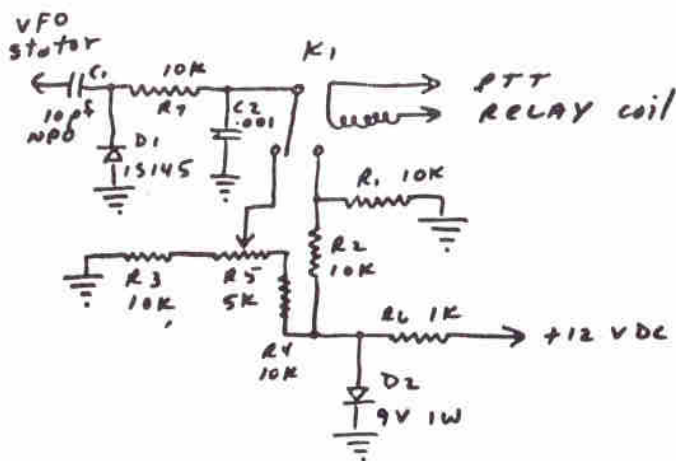

de Florida Skip

Then there's the story of the baby sardine that was frightened by a submarine and went crying to its mother. "There, there, dear," soothed Mama Sardine. "Don't be upset. It's only a can of people!"

—Service

Antenna Tuner Used By – Allen L. Smith – W4IPP
714 South Main Street
Lexington, North Carolina 27292

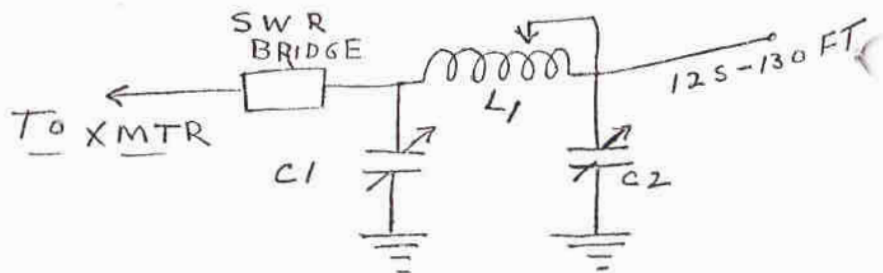

C1 C2 100 to 150 MMF (Not critical). If large capacity is used minimum capacity may be too high on higher frequency bands. If maximum capacity is too low for 75 meters put fixed condenser in parallel with each variable. Plate spacing should be sufficient to take power of transmitter.

L1 Rotary Inductor--Should have at least 30 turns of wire and large enough to take power of transmitter.

Antenna Length--125 to 130 feet. This length seems to work best on all five bands (10-15-20-40-75).

All equipment should be grounded.

Tune for lowest SWR.

For Best Results – Do NOT Put In Metal Cabinet.

NOTES FROM ARRL

A third-party message traffic agreement has been signed between Trinidad & Tobago, and the United States, effective December 18. It has been pointed out to me that this is the first instance of "British" willingness to permit its amateurs to handle messages for third parties. Let's hope it is hand-writing on the wall.

In addition to its random sampling of mail-examination licensees through

calls, FCC is undertaking inspection of amateur station log books in several situations. One is where SSTV "Playboy" picture transmission is alleged; another is alleged harmful interference to net operations; a third is random sampling of renewal applications, to ascertain the truth of the affirmation that the activity requirements have been met.

FOR SALE

Galaxy GT550, RF550, RV550, SC550, F3 and AC-400. Complete station for \$500.00.

Set 2 meter sidewinder + 911A AC supply \$125.00
2-Collins 516E1 DC supply (for KWM-2 Heathkit, etc.) . . \$40.00 each
Central Electronics 20A (rack mount or table) and 458 VFO . . . \$125.00
Model 19 RTTY table complete and in excellent condition. Make offer or trade.

Hy-Gain 3 element 6 meter beam, new \$10.00
Collins R-388-Excellent . . . \$400.00
Central Electronics MM2 Monitor \$75.00

Galaxy FM-210, 94-94, 34-94, 76-76, 70 T&R XTALS + AC210
Booster \$150.00
Will deliver larger items to Omaha or vicinity.

C. E. Conner, WØNGG/Ø
5324 W. Wilkins
Lincoln, Nebraska 68524
Phone: 799-3508

WANT TO BUY

I'm wondering if there are any control/power cables available in the area for the RCA CMC-20B1 series radios? Does anyone have any of the Cannon connectors available?

I have some spare Motorola control leads and speaker mounting brackets that I will sell for a reasonable price.

John Snyder, WØWRT
Phone: 556-1538
3221 S. 45 St., Omaha

MEMBER NEWS

Mr. Editor:

We look forward each month to receiving the great little HAM HUM. It's interesting to read the various articles in it written by fellow members.

I've noticed several articles about vacations taken in the past. Would like to say that Louie Olson, WNØFFA, my son, Frank and I left December 3, 1971 to attend a hamfest in Faribault, Minnesota, put on by the Handy Ham's PICO Net which operates at 3925 all day each day of the week except evenings. We enjoyed a FB ham dinner with refreshments and many eyeball QSOs and ragchews in the afternoon of December 4.

On the way to and from Faribault, we stayed at the home of Gary Knutson, WBØASO, and his family in Vincent, Iowa. Sunday morning, December 5, we enjoyed using his FTDX560 to talk back home to Harold, KØJBC, Lloyd, KØDKM and Mike, WBØBMV, who ran a patch to my XYL to let her know we would be home in the afternoon.

The following week we went to our first Christmas party sponsored by Ak-Sar-Ben Radio Club. This was a nice party, preceded by the annual meeting and election of officers.

By the way, when we were in Minnesota several called us DX from Omaha. Hi.

Happy New Year to everyone.

73s

Don Henderson, WAØZKW

A woman is the only being that can skin a wolf and get a mink.

2 METER JANUARY HAM-HUM SPECIALS!!

REGENCY HR-2MS "SCANNER"
2 Meter FM Transceiver **\$319⁰⁰**

15 Watts out!

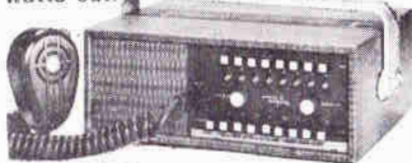

Like the HR-2A, a solid 15 watt output, & 8 channel provisions. Receiver has scanning capability (with crystals installed) for monitoring many active frequencies so you know what's going on & don't miss activity due to monitoring one freq. etc. Operates from 12VDC. Includes 146.94 crystals, bracket and mic.
134HH007, \$319.00

REGENCY HR-2A
"THE WORKHORSE"
2 Meter FM Transceiver

\$229⁰⁰

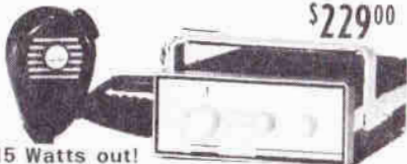

15 Watts out!

A big reputation for POWER at a modest price. The 6 channel capability serves most needs, and the 15 watt output really does a good job, coupled with the sensitive receiver. Comes with 146.94 crystals, bracket and microphone.
134HH005, \$229.00

BONUS Items for January

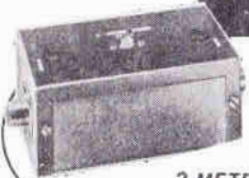

2 METER BANDPASS FILTER

Use on rigs to 190 watts input. 2 mHz bandpass is variable through 2 meters, giving 40db attenuation from edge of passband. Attenuates harmonics, etc. - but also use to minimize receiver cross-mod from TV/FM/Commercial strong signals, etc.

2 METER MOBILE ANTENNA WITH TRUNK MOUNT

Provides solid 3db gain in the 2 meter band. Also has easy-no holes mount to attach to trunk lip for easy mounting. For 52 Ohm feedline.

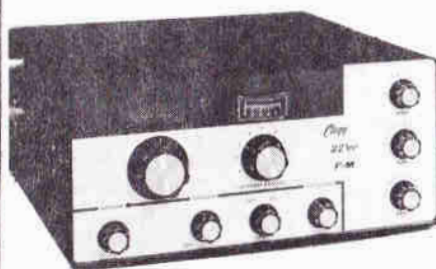

**CLEGG 22'er FM
TUNABLE RECEIVER** **\$384⁹⁵**
115VAC/12VDC
Over 27 Watts Output

Supplied with transmit crystals for both 146.34 and 146.94, the receiver is very stable and tunes 145.9 to 148.5 mHz. Guaranteed minimum 27 watts out—typically well over 30 watts out. Dual power supply internally for fixed/mobile use, speaker and mike included. Takes up to 9 xmt. crystals and has spot switch.
107HH043, \$384.95

BONUS →

On all orders received in January, Cash/MasterCharge/BankAmericard you may specify FREE (1) Filter AND (1) Antenna as above at no charge other than shipping costs, when added to order for one of the units described above.



WORLD RADIO

3415 West Broadway • Council Bluffs, Iowa 51501
Phone 328-1851